

MARTINETTO IDRAULICO

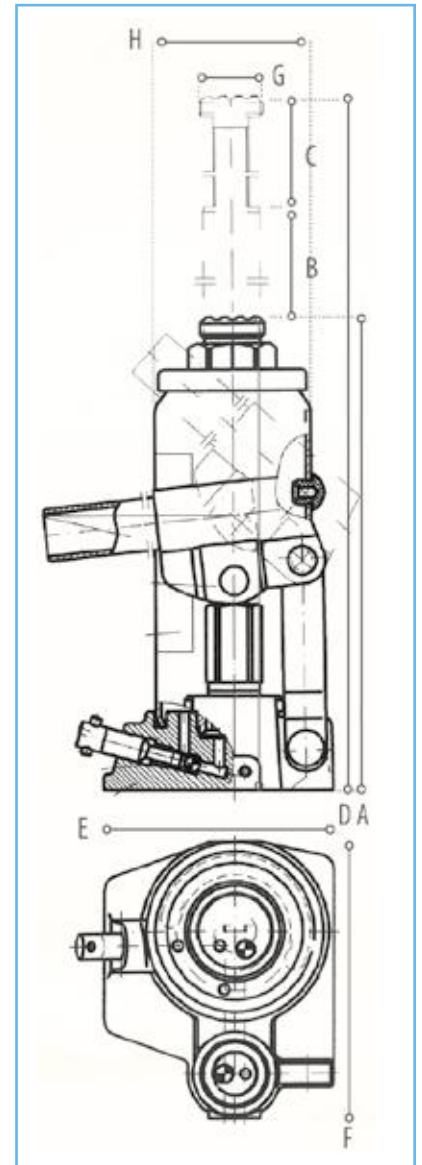

CODICE	PORTATA (kg)	DIMENSIONI (mm)								ALTEZZA MINIMA	ALTEZZA MASSIMA	ALTEZZA REGOLABILE	PESO (kg)
		A	B	C	D	E	F	G	H				
NDB30000	30000	255	150		405	173	173	56	121	255	465		13,3