

VERRICELLO ELETTRICO 230 V 50 HZ



In dotazione
10 mt di cavo

CODICE	PORTATA (kg)	ALZATA MASSIMA M	VELOCITÀ DI SOLLEVAMENTO m/min	DIAMETRO CAVO mm	PESO (kg)	POTENZA (kw)
CP0.DKL500	500	18	12	20 x 7	29	2.0

ACCESSORI VERRICELLO ELETTRICO (opzionali)

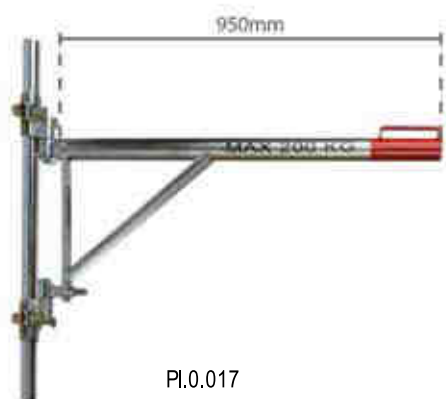

PI.0.017



ST.0.011



CP.0.CEC

Portata 200 kg

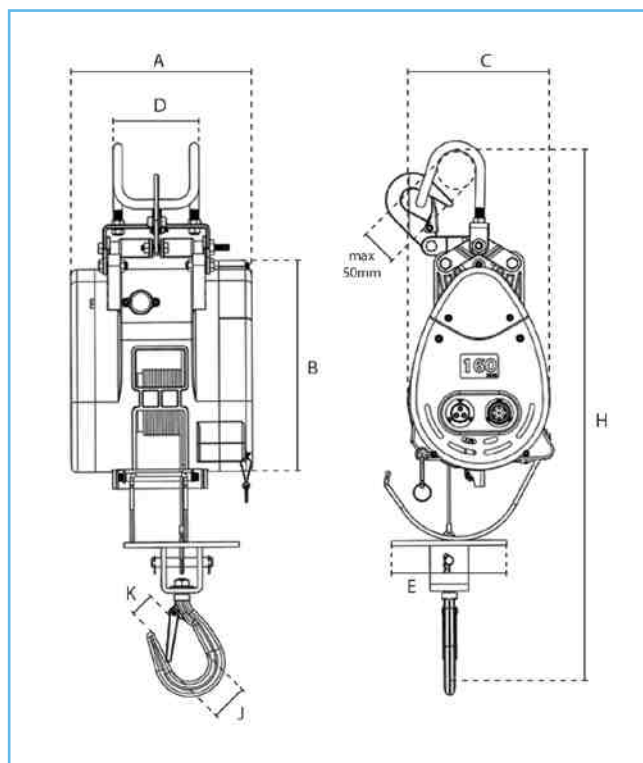

CODICE	A	B	C	D	E	H	J	K
CP.0.DKL500	210	308	240	146	155	670	49	41