

VERRICELLO ELETTRICO A 220V

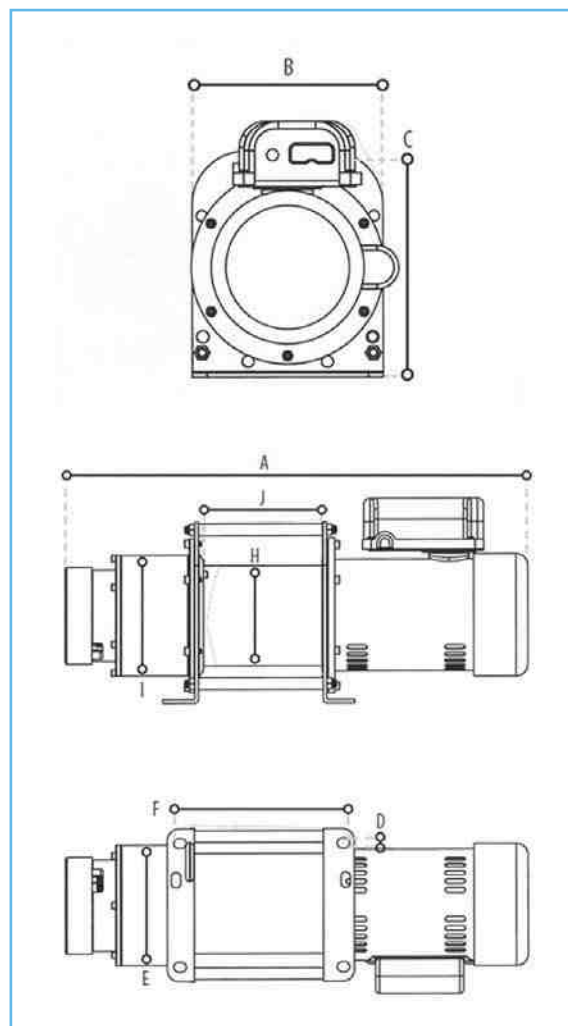

CODICE	PORTATA (kg)	Velocità m/min	DIMENSIONI (mm)									DIMENSIONE CAVO	ASSORBIMENTO IN PARTENZA P/H	PESO (kg)
			A	B	C	D	E	F	H	I	J			
NVED200	200	15	530	201	261	Ø13	155	160	Ø65	Ø155	116	6mm/30m	300	34