

NSW80

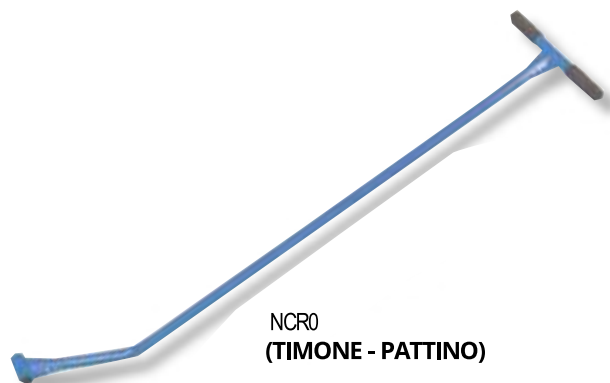
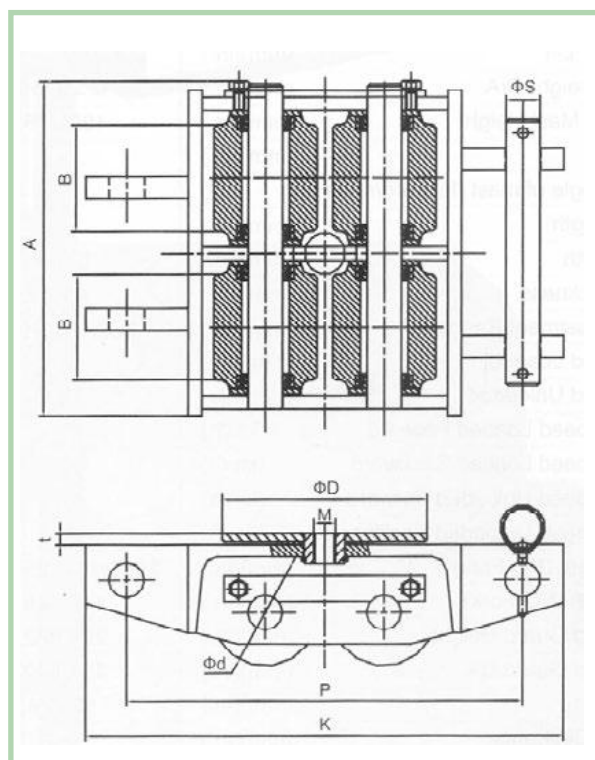

NCR0
(TIMONE - PATTINO)

Modello	NSW80
Portata (kg)	8000
Peso netto (kg)	42
A (mm)	344
K (mm)	460
P (mm)	400
H (mm)	144
Ø S (mm)	31
Rullo	poliuretano
Rullo (numero)	4
Rullo diametro d (mm)	120
Rullo B (mm)	140
Diametro parte rotante D (mm)	240