

TAVOLA ROTANTE

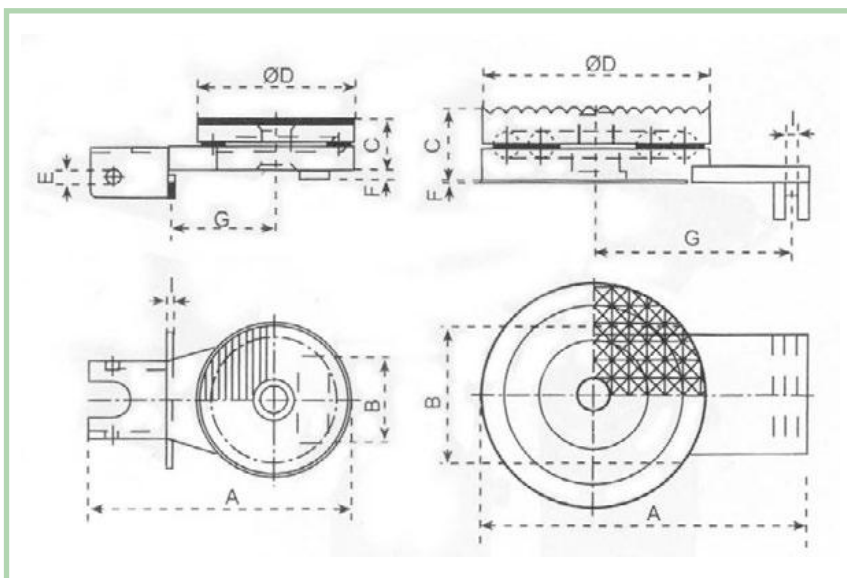

Modello	NTR20
Peso (kg)	4,5
A (mm)	220
B (mm)	86
C (mm)	41
Diametro D (mm)	128
E (mm)	11
F (mm)	8
G (mm)	88
I (mm)	5