

TAVOLA ROTANTE

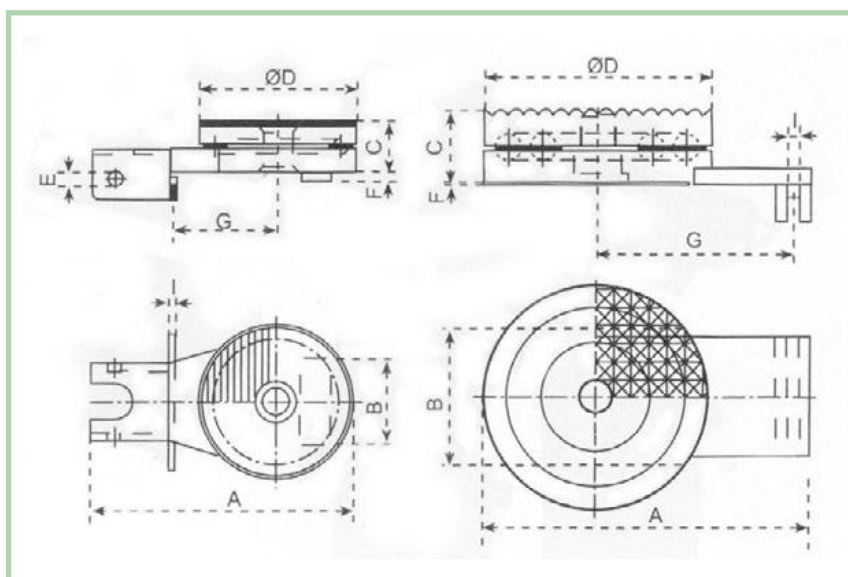
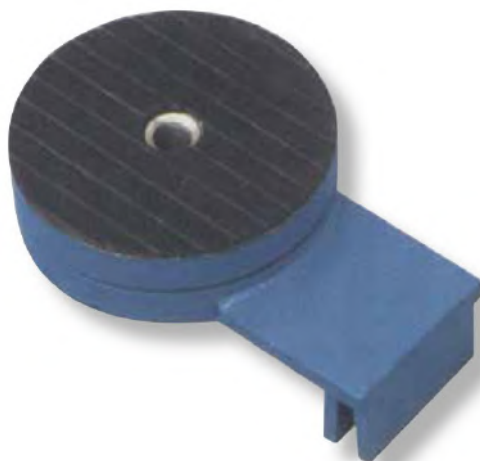

Modello	NTR50
Peso (kg)	18,9
A (mm)	360
B (mm)	128
C (mm)	64
Diametro D (mm)	220
E (mm)	-
F (mm)	3
G (mm)	235
I (mm)	11